

ENROLLADOR DE CABLE serie 1400

- Fabricado acero y pintado con Polímero
- Soporte lateral en aluminio
- Colectores para potencia de 16 – 50 – 100A
- Muelle de acero para garantizar un mayor duración
- Grado de protección IP65
- Se entrega sin cable o con cable H05 VV-F y H07 RN-F
- Para cables de 1 a 12 conductores
- Temperatura de trabajo : -5°C / +40°C
- Velocidad máxima de recogida: 30 m/minute
- Potencia de aislamiento del colector 2,5 KV

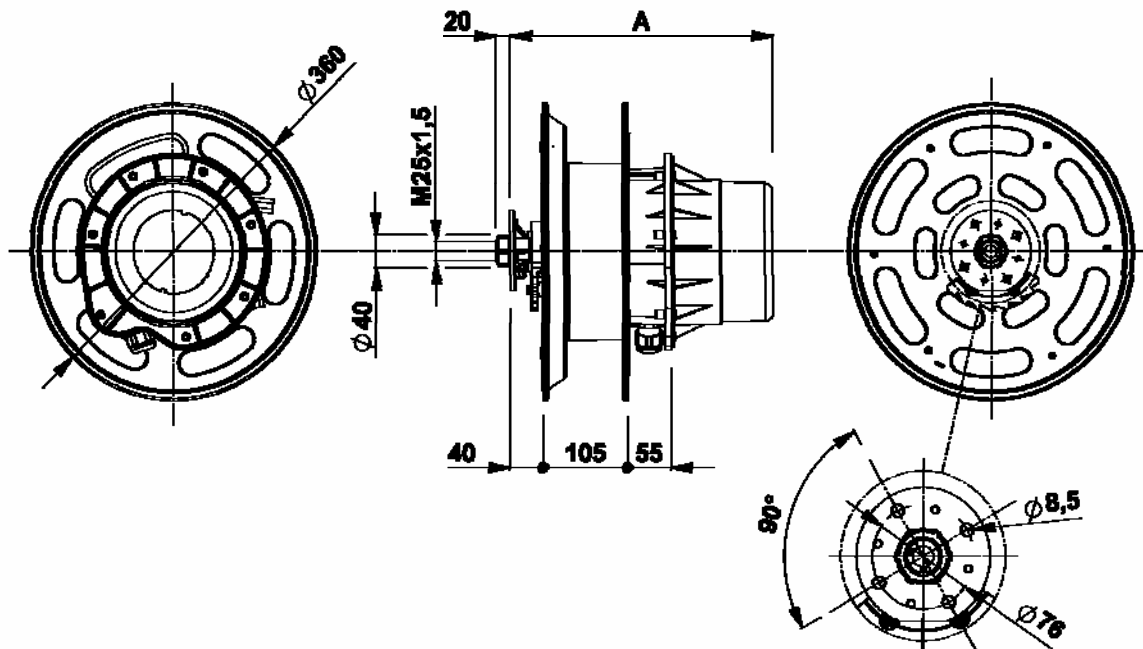

Nº de conductores	Sección (mm ²)	Capacidad anillo colector(A)	Metros enrollados (m)	Ref SIN CABLE	Ref. CON CABLE	KW		Tipo de cable	Cable diámetro (mm)	Dimensiones (A)			
													
1 x	16	50	20	1470	1420	50A		H05 V-F	8	330			
	25	100	18	1471	1421	100A			10				
2 x	16	50	10		1424	50A		H05 BQ-F	15	330			
		100			1425	80A				380			
3 G	2,5	20	20	1476	1428	230V	2,0	230V	3,5	H05 VV-F	10	330	
			18		1428 RNF					H07 RN-F	11,5		
4 G	1,5	20	20	1478	1432 RNF	400V 3F+T	4,0	400V 3F+T	6,0	H07 RN-F	10,5	330	
			18		1434					H05 VV-F	11		
	2,5	20	15	1479	1434 RNF				7,0	10,0	H07 RN-F	12,5	330
			18		1480						1435	H05 VV-F	
	4	50	12	1481	1435 RNF				11,0	15,0	H07 RN-F	12,5	330
			10		1436						H05 VV-F	14	
	6	50	8		1436 RNF				17,0	22,0	H07 RN-F	15	330
					1438 RNF						H07 RN-F	17	
5 G	1,5	20	18	1483	1440	400V 3F+T+N	4,0	400V 3F+T+N	6,0	H05 VV-F	10	330	
			15		1440 RNF					H07 RN-F	12		
	2,5	20	15	1484	1442				7,0	10,0	H05 VV-F	13	330
			12		1442 RNF						H07 RN-F	13,5	
	4	50	15	1485	1443				11,0	15,0	H05 VV-F	13	330
			12		1443 RNF						H07 RN-F	13,5	
			8		1444 RNF						H07 RN-F	16,5	330
	8 x	1	20	18	1487				1450	3A		H05 VV-F	10
1,5		15		1488	1452	4,5A		11					
2,5		12			1454	7,5A		14					
12 x	1	20	15	1490	1460	3A		H05 VV-F	13	380			
	1,5		12		1462	4,5A			14				
	2,5		8		1464	7,5A			16,5				



Opcionales serie 1400

Soporte pivotante – Ref. 1401

- Solo para enrolladores que vayan a ser utilizados manualmente
- Añadir la boca de salida para cable (referencia 1406)

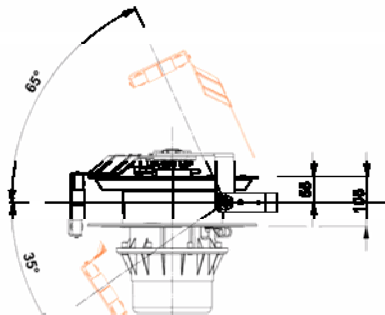
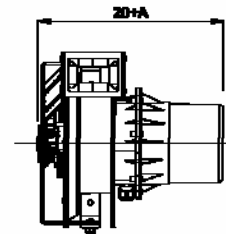
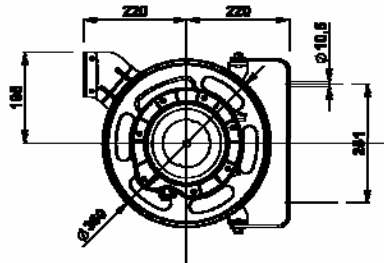

Soporte fijo Ref. 1403

- Para fijar a pared, suelo o techo.
- Debe ser instalado con la boca de salida referencia . 1406

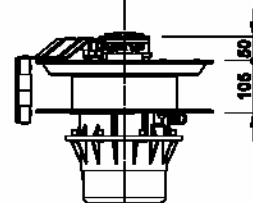
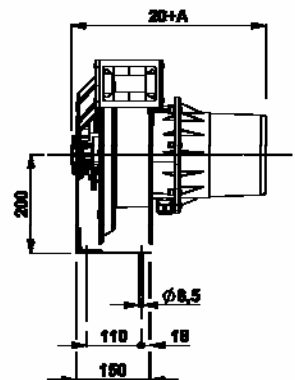
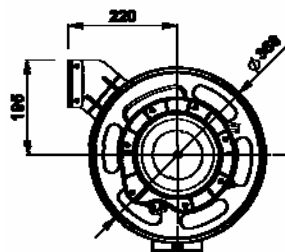
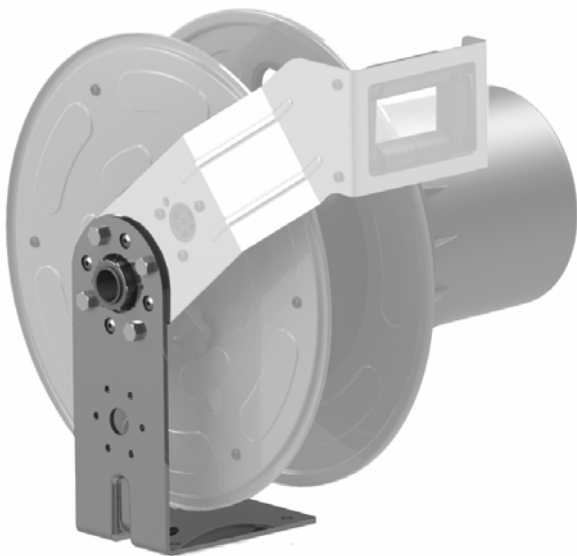

Brazo con guía de salida con rodillos – Ref. 1406

- Completo con trinquete.

